



Chipinfos Electronics Co., Ltd.

An Independent Professional IC

Testing Service Provider



A brief introduction of CIS

- Established in 2017, positioned as the CDTO (Contract Development Testing Organization) model.
- A leading independent third party testing service provider in China.
- Providing testing service throughout the entire IC industry chain.
- Value added services: design verification services, wafer testing services, and finished product testing services.
- Experienced in high-end chip testing to build its core competitiveness, especially testing services in the field of complex SoC chips and complex digital-analog hybrid chips.

Development path

- Registered CIS in KunShan

2017

2018

2019

2020

2021

2022

- Over 100KK pcs chipsets were tested and shipped;
- Application-oriented strategy established
- Awarded as “innovative star” separately by KunShan and SuZhou government;

- Strategic layout of vehicle-level chip testing
- Expanded business in RFIC field and penetrate into wider Chinese market

- Mass production and shipment started
- Passed ISO9000:2015 certification
- Awarded as “KunShan Innovation Angel”

- Firmly implemented import substitution strategy with vendors and customers
- Awarded as “High Technical Company”

- IATF16949 certified;
- Shanghai high performance Lab established
- Suzhou 2nd plant started

Certificates

intertek
Total Quality Assured.

CERTIFICATE OF REGISTRATION

This is to certify that the management system of:

Kunshan Chipinfos Electronics Co., Ltd.

Main Site: 2nd Floor, Building 4, No. 388, Shuanghua Road, Huaqiao Town, Kunshan City, Suzhou City, Jiangsu Province, P. R. China
has been registered by Intertek as conforming to the requirements of:

ISO 9001:2015

The management system is applicable to:

Technology Development and Services of IC final test

Unified Social Credit Identifier: 91320583MA1U1HWJXF
Certificate Number: 112009004
Initial Certification Date: 15 September 2020
Date of Certification Decision: 15 September 2020
Issuing Date: 15 September 2020
Valid Until: 14 September 2023



intertek 014

Calin Moldovean
Calin Moldovean
President, Business Assurance

Intertek Certification Limited, 10A Victory Park, Victory Road, Derby DE24 6EY, United Kingdom
Intertek Certification Limited is a UKAS accredited body under schedule of accreditation no. 014.



In the issuance of this certificate, Intertek assumes no liability to any party other than to the Client, and then only in accordance with the agreed upon Certification Agreement. This certificate's validity is subject to the organization maintaining their system in accordance with Intertek's requirements for system certification. Validity may be confirmed via email at certificates.validation@intertek.com or by scanning the code to the right with a smartphone. The certificate remains the property of Intertek, to whom it must be returned upon request.

The annual validity of the certificate can also be checked through the website <http://www.cncac.gov.cn> of CNCA in China.



intertek
Total Quality Assured.

CERTIFICATE OF REGISTRATION

This is to certify that the management system of:

Kunshan Chipinfos Electronics Co., Ltd.

Main Site: 2nd Floor, Building 4, No. 388, Shuanghua Road, Huaqiao Town, Kunshan City, Suzhou City, Jiangsu Province, P. R. China
has been registered by Intertek as conforming to the requirements of:

ISO 9001:2015

The management system is applicable to:

Technology Development and Services of IC final test

Unified Social Credit Identifier: 91320583MA1U1HWJXF
Certificate Number: 112009004
Initial Certification Date: 15 September 2020
Date of Certification Decision: 15 September 2020
Issuing Date: 15 September 2020
Valid Until: 14 September 2023



intertek 014

Calin Moldovean
Calin Moldovean
President, Business Assurance

Intertek Certification Limited, 10A Victory Park, Victory Road, Derby DE24 6EY, United Kingdom
Intertek Certification Limited is a UKAS accredited body under schedule of accreditation no. 014.



In the issuance of this certificate, Intertek assumes no liability to any party other than to the Client, and then only in accordance with the agreed upon Certification Agreement. This certificate's validity is subject to the organization maintaining their system in accordance with Intertek's requirements for system certification. Validity may be confirmed via email at certificates.validation@intertek.com or by scanning the code to the right with a smartphone. The certificate remains the property of Intertek, to whom it must be returned upon request.

The annual validity of the certificate can also be checked through the website <http://www.cncac.gov.cn> of CNCA in China.



Testing based Ecosystem

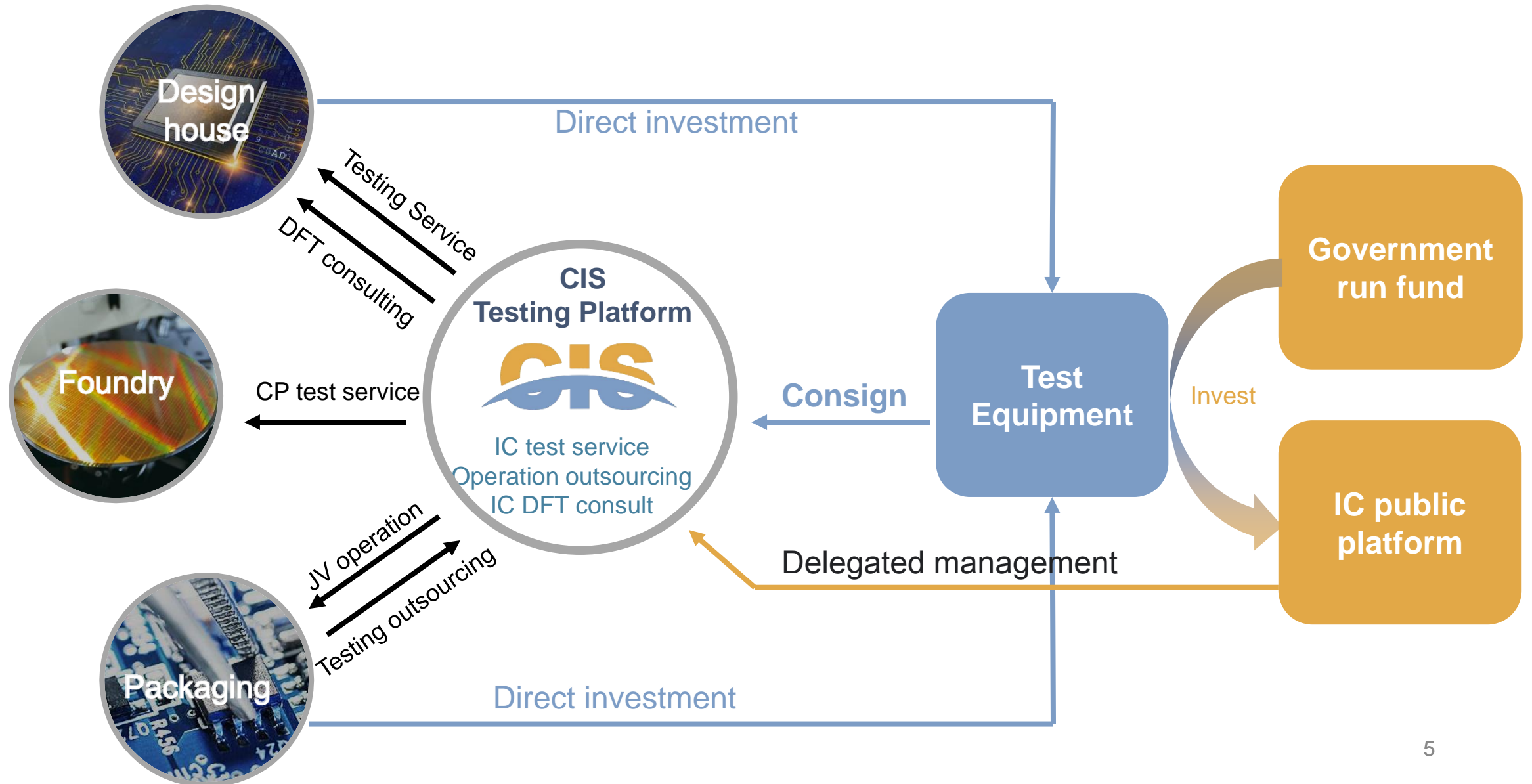

Focusing on High-end chip

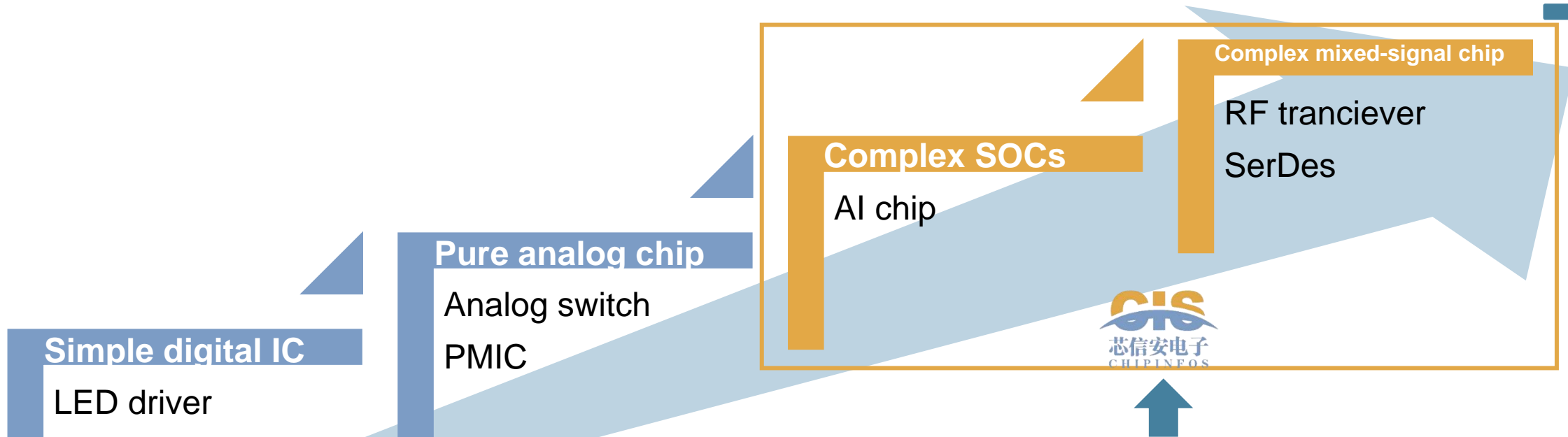

The only third-party independent chip in China positioned in the field of high-end chip testing, planning and layout around the test requirements of **automotive-grade chips**, **high-end digital chips (AI chips, etc.)**, **high-end analog chips (signal chain, etc.)**, and **high-end RF chips (millimeter wave, etc.)**. test service company

Service scope

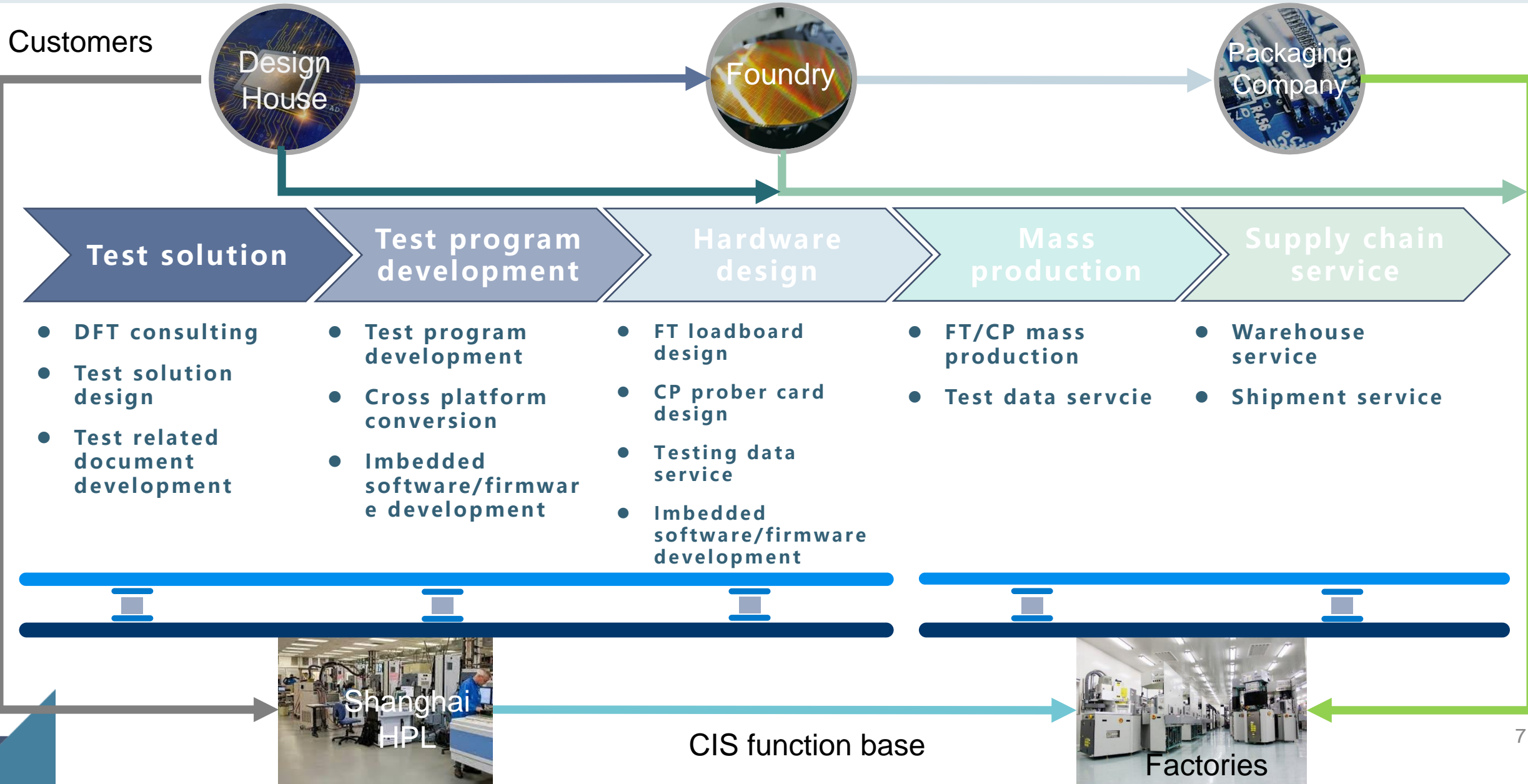

Founders

Wang, Yang
Founder
CEO

- Master, EE Fudan University
- Over 18 years working experience for SoC testing, RFID and IoT
- Leading testing solution development for several SoCs in Teradyne Inc.
- Former vice-president of Quanray Electronics

Qixin Chen
Co-founder
CMO & Sales

- Master, EE Fudan University
- Over 18 years engineering and management experience in Broadcom, Verigy and Agilent, supporting global customers.
- Former operation head of Broadcom China

Liang Li
Co-Founder
CTO

- Master, EE Shanghai Jiaotong University
- Over 17 years experience as testing expertise in Advantest, Broadcom, Verigy, supporting pilot customers such as Huawei, RDA, etc.
- Former Broadcom testing scientist and owner of testing IPs
- Former chief of expertise(COE) in Advantest

Key Staff Pillars

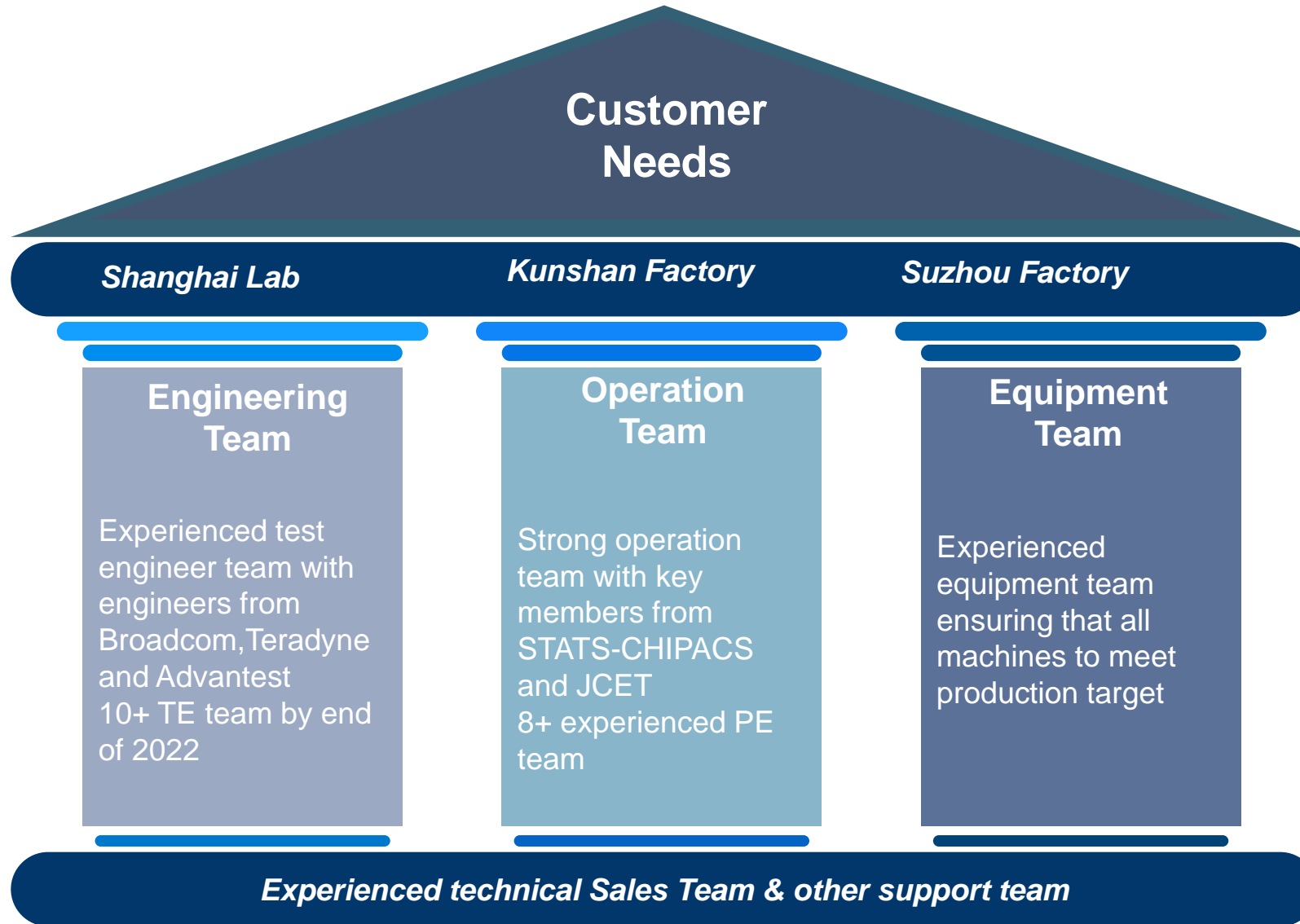

Service model workflow

Customers

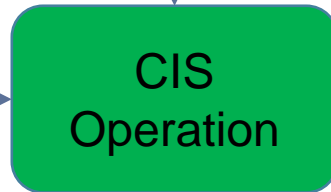
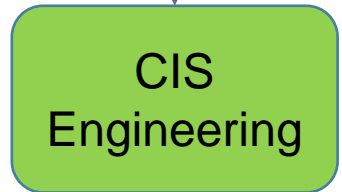
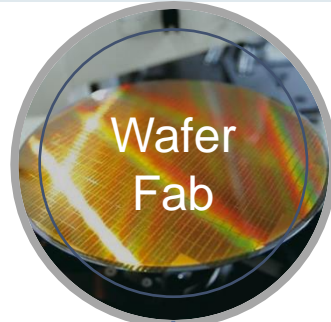

CIS Function team



CIS Base

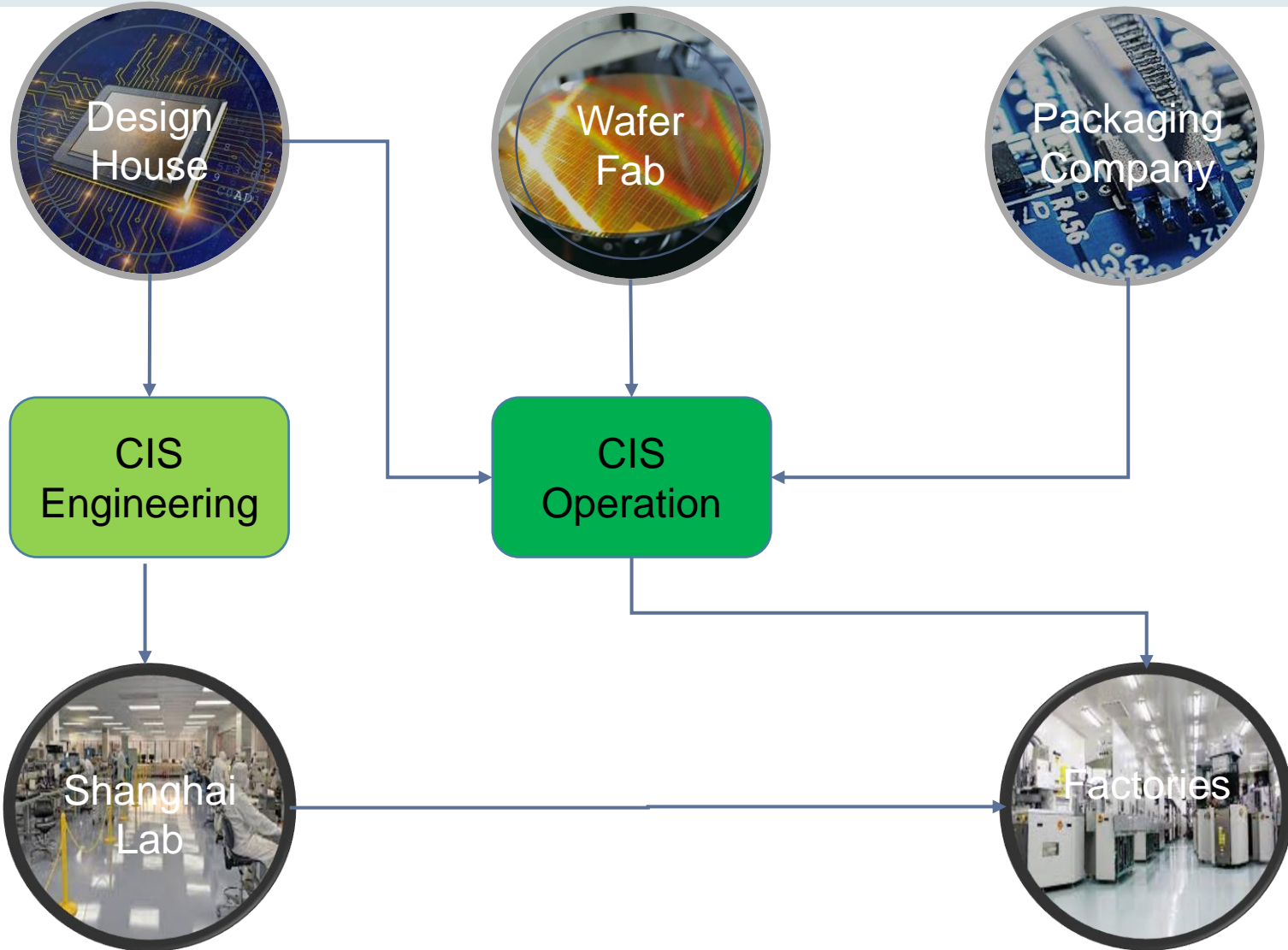

CIS Main Base

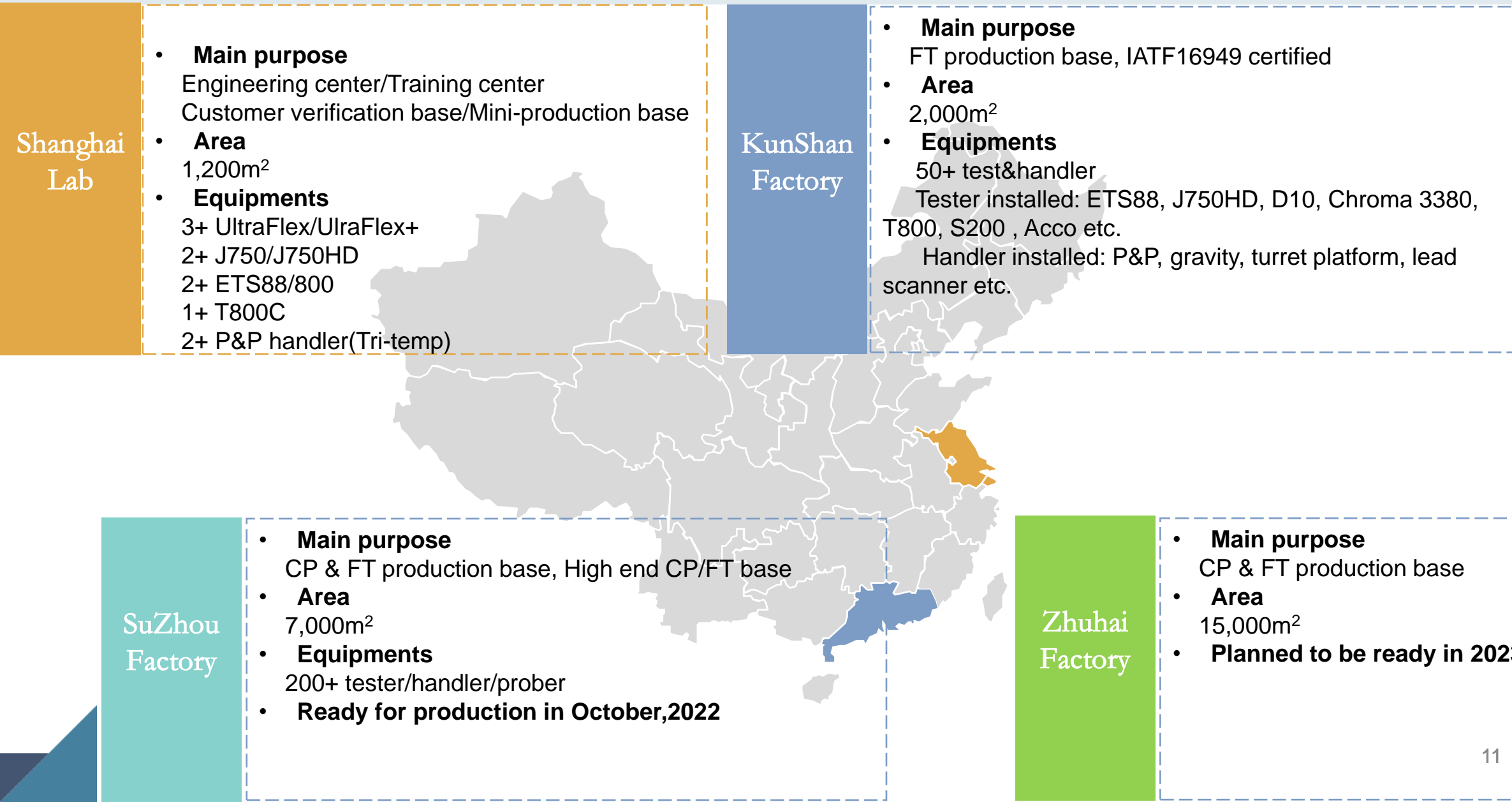

CIS Capability Matrix

Tester



UltraFlex/UltraFlex+



J750/J750HD



Xcerra D10



Chroma 3380D/P



T800



S200



ETS-88



AccoTest

Handler



Turret platform



Gravity handler



Tri-temp P&P handler

Package

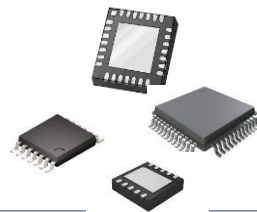
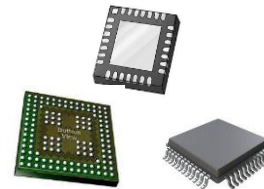
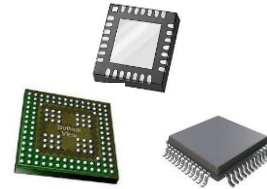

Apps

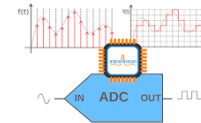
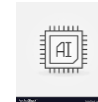

Customers



天数智芯



artosun 酷芯微电子



Enflame



artosun 酷芯微电子



SENSCOMM



COMTEK 昆泰芯微电子



PHY+ MICROELECTRONICS



CHIPONE 集创北方



Quanray Electronics



mi



ETA SOLUTIONS
Powering Minds of the Smarts



ALPHA & OMEGA SEMICONDUCTOR

Application oriented & customized solutions

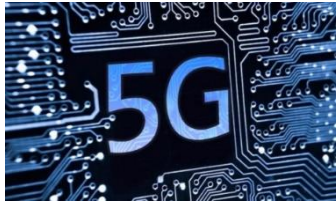

RF Wireless



Millimeterwave Sensor IC Testing Solution

- To replace NI solution with ~50% cost reduction

3 customers have been offering RFICs for multiple IoT equipment vendors



IPM & Power IC



Specific CP Testing Solution

- To provide complete new testing platform for one global pilot driverIC vendor

Over 20Mpcs testing quantities per month from this year



Sensor & HPMS



Auto-level Pressure Sensor Calibration +Testing

- To penetrate into auto-level IC testing solutions

Have served one of the major TPMS IC vendors in China, who is the qualified IC vendor for BYD



Complex SoC



Testing + Configuration Services

- **To Develop Testing Solution**
- To satisfy diversified queries

Have served one leading US-based IC design house, who has been qualified vendor for companies like DELL

CIS is the leading independent testing service vendor targeting at high end markets, such as automotive level chipsets, high end digital SoCs (ex.: AI chipsets), high performance mixed signal ICs, high end RFICs (ex.: millimeterwave ICs)

CIS Leading Strategic Focus

- High performance and complex SOC
 - AI
 - 5G
 - SerDes
- Vehicle-Level testing base
 - The only IATF16949 certified test-only supplier
 - More certified service provided for vehicle level chips
- Strong test engineering team
 - Shanghai based experienced team
 - Global training center in Shanghai HPL

ERP/MES/WMS System Hierarchy

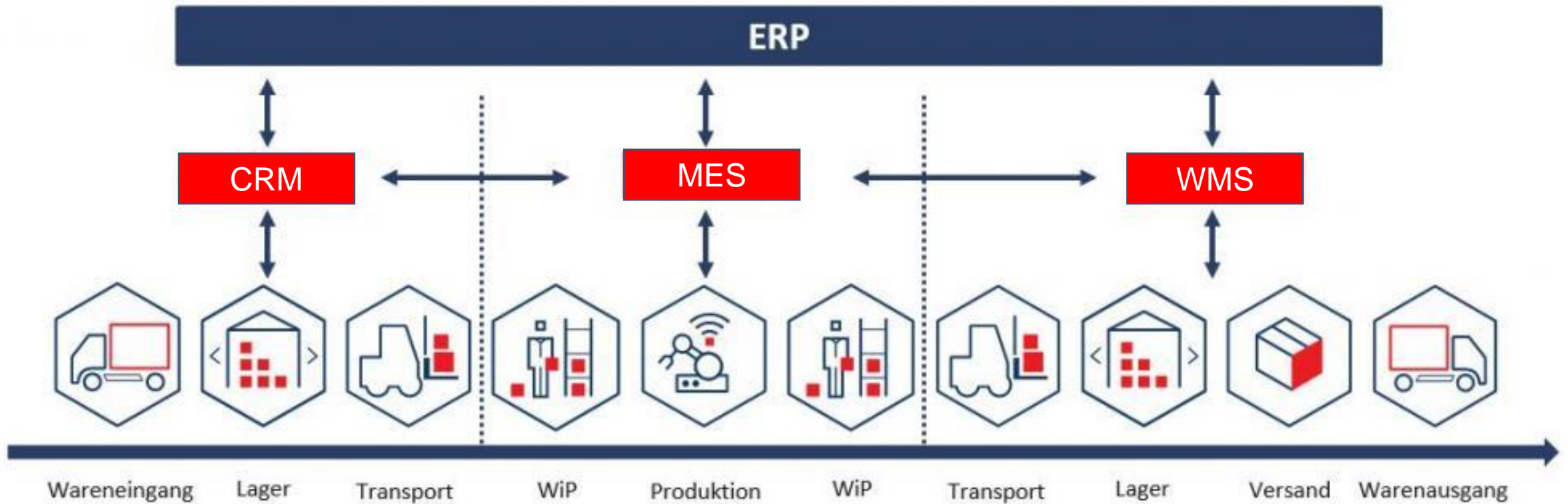

System applications

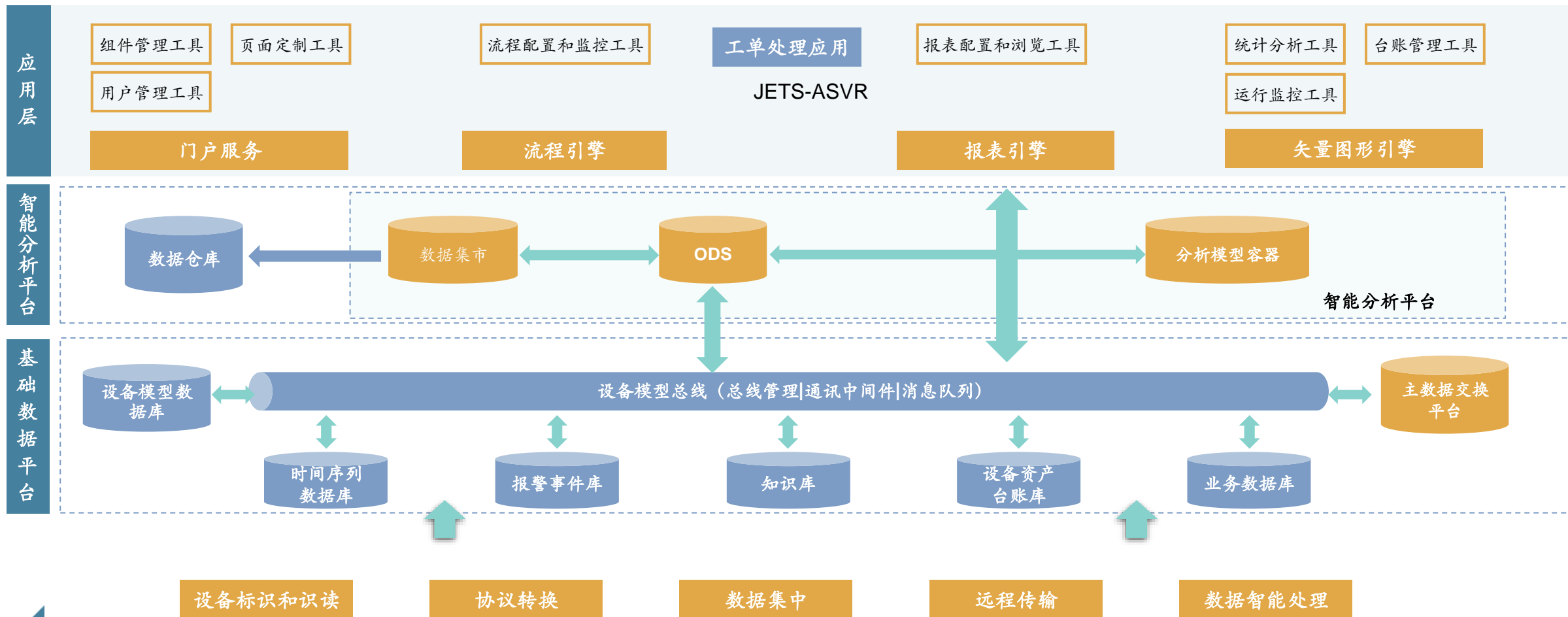

Thanks!